

High-speed lightwave component analysis

Application Note 1550-6

Characterizing system components

- Laser and LED transmitters
- Photodiode receivers
- External modulators
- Optical components

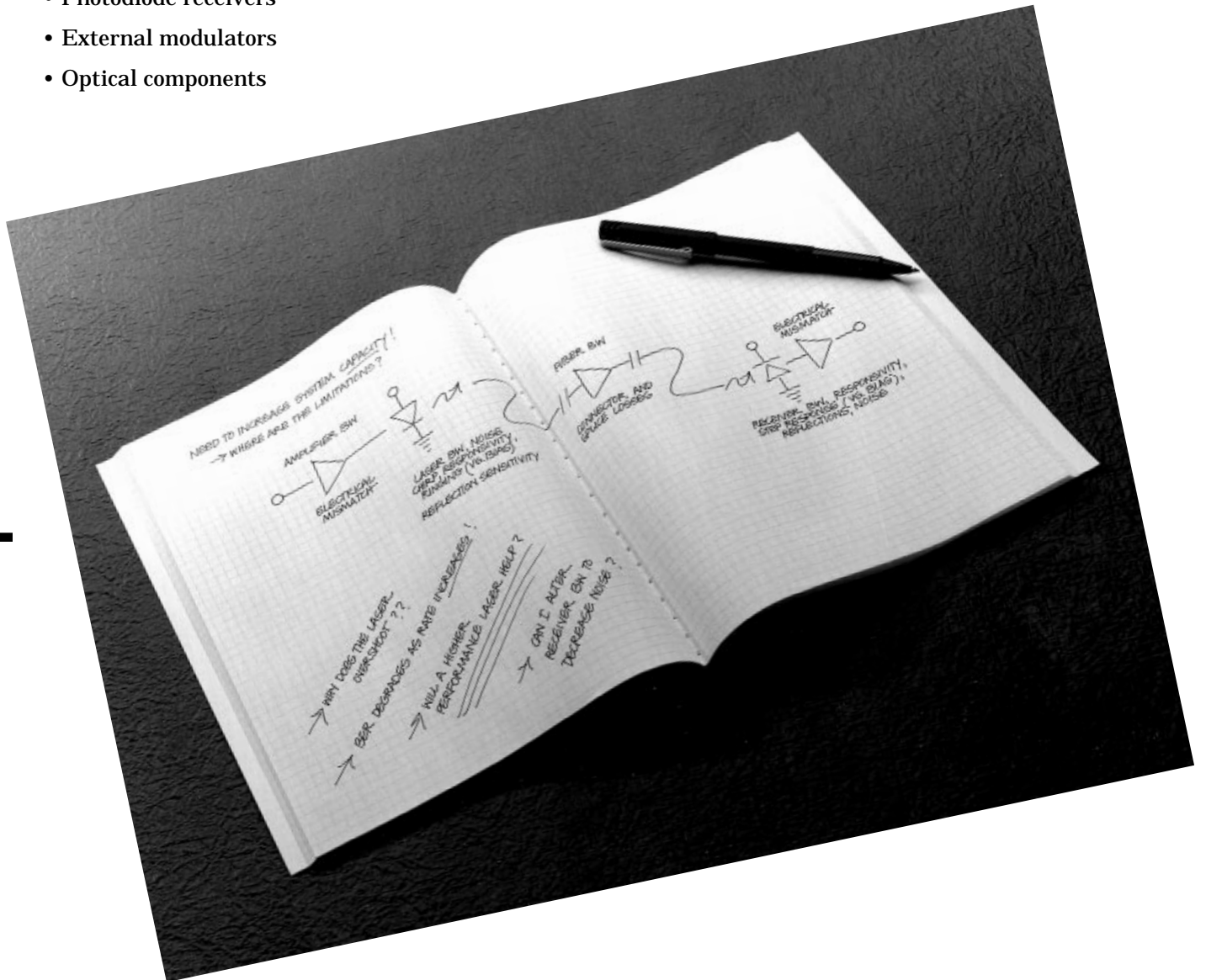

As lightwave transmission systems become more advanced, component designers and manufacturers must maximize the performance of their devices. For example, one parameter often used to specify digital system performance is bit error rate. However, it is difficult to specify individual components in such terms. Rather, fundamental measurements such as gain, bandwidth, frequency response and return loss can be appropriate. The Lightwave Component Analyzer (LCA) is used to measure the linear transmission and reflection characteristics of a component as a function of modulation frequency. Measurements are calibrated and can be performed at modulation rates up to 20 GHz.

Table of Contents

Introduction

General measurement techniques and considerations	3
The Lightwave Component Analyzer (LCA) family	4

Lightwave transmitter measurements (E/O)

Modulation bandwidth, frequency response, and conversion efficiency	5
The effects of bias on laser performance	7
Laser pulse measurements	7
Laser reflection sensitivity	8
Modulation phase response	8
Laser input impedance	9

Electro-optic external modulator measurements (E/O)

Modulator bandwidth and responsivity	11
--------------------------------------	----

Lightwave receiver measurements (O/E)

Modulation bandwidth, frequency response, and conversion efficiency	12
Photodiode pulse measurements	13
Photodiode modulation phase measurements	15
Photodiode output impedance	15

Optical component measurements (O/O)

Transmission measurements	17
Fiber length and propagation delay	17
Fiber modulation phase stability	18
Reflection measurements	18
Methods for measuring lightwave reflections vs. distance	18
Achieving both high resolution and long range	20

Electrical component measurements (E/E)

Appendix 1: Signal relationships in opto-electric devices	21
--	----

Appendix 2: Operation in the time domain

Basic considerations	22
Range and resolution	23
Improving measurement accuracy through gating	23

Introduction

General Measurement Techniques and Considerations

The concept of lightwave component analysis is straightforward. Measurements are made of the small-signal linear transmission and reflection characteristics of a variety of lightwave components. A precise electrical (signal generator) or optical (laser) source is used to stimulate the component under test and a very accurate optical or electrical receiver measures the transmitted (or reflected) signal. Since characterization over a range of modulation frequencies is required, the frequency of modulation is normally swept over the bandwidth of interest.

Measurements are typically comprised of the appropriate ratio of microwave modulation current (or power) and lightwave modulation power (see Figure 2).

While Figure 1 demonstrates the basic concepts of lightwave component analysis, the specific measurement processes are illustrated later. An analysis of how various signals are used in the measurement process is found in Appendix 1, "Signal Relationships in Opto-electric Devices."

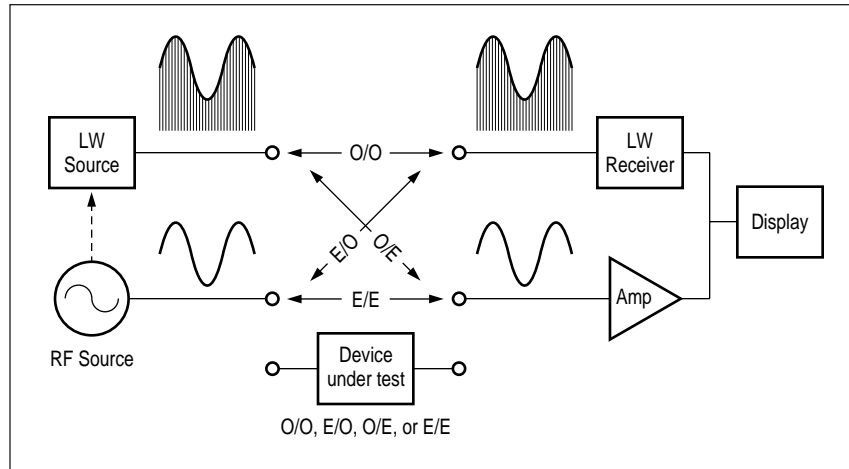

Figure 1. LCA Block diagram

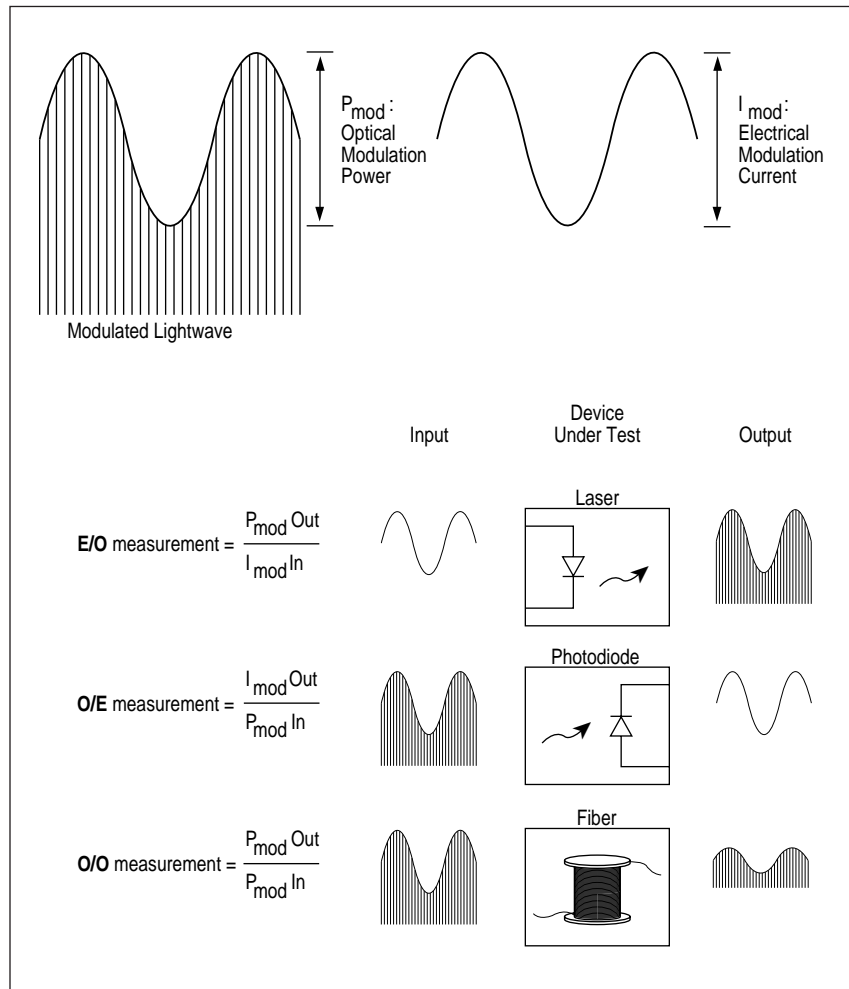

Figure 2. Measurement signals

E/O Measurements (Lasers, LED's)

The measurement of an E/O transducer is a combination of input modulating current and output optical modulation power. Slope responsivity is used to describe how a change in input current produces a change in optical power. Graphically this is shown in Figure 3.

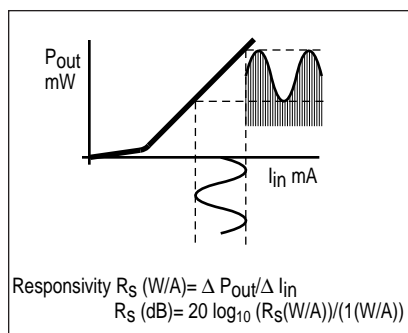

Figure 3. E/O slope responsivity

An LCA measures input modulating current and output modulation power and displays the ratio of the two in Watts/Amp, either linearly or in decibels.

O/E Measurements (Photodiodes)

The measurement process for O/E devices is similar to E/O devices. The measurement consists of the ratio of output electrical modulation current to input optical modulation power. Slope responsivity for O/E devices describes how a change in optical power produces a change in electrical current. Graphically this is shown in Figure 4.

The LCA measures the input optical modulation power and output modulation current and displays the ratio of the two in Amps/Watt.

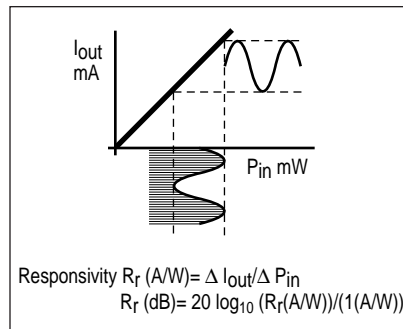

Figure 4. O/E slope responsivity

O/O Measurements

Characteristics of purely optical devices can also be measured. In this case, both the stimulus and response are modulated light. The ratio measurement is simply one of gain or loss versus modulation frequency.

Measurement Process

To simplify the process of making measurements, LCAs have a built in "Guided setup" feature. This will lead the user through the basic measurement setup and calibration features.

Measurement Calibration

The key to making accurate E/O, O/O, or O/E measurements is calibrated instrumentation. The

instrument lightwave source and receiver are individually characterized. The systematic responses of the components making up the LCA can then be removed, yielding the response of the device under test (DUT). (See Appendix 1, "Signal relationships in optoelectric devices" for more detail.)

The LCA Family

There are several instruments in the LCA family. Their characteristics are summarized below:

LCA	λ (nm)	Modulation Frequency Range
HP 8702	850, 1300 or 1550	300 KHz-3/6 GHz
HP 8703	1300 or 1550, FP or DFB	130 MHz-20 GHz
HP 8510/83420 ¹	1300 or 1550, FP or DFB	45 MHz-20 GHz
HP 8720/83420		

Please refer to the Hewlett-Packard "Lightwave Test and Measurement Catalog" for a complete listing of Lightwave Component Analyzers as well as other lightwave test equipment.



¹ See HP Product Note 8510-15.

Lightwave Transmitter Measurements (E/O)

The LCA is used to characterize the transmission and reflection parameters of laser and LED sources with respect to modulation frequency. The transmission measurements to be discussed include:

- modulation bandwidth and frequency response
- conversion efficiency
- the effects of bias
- pulse measurements
- reflection sensitivity
- modulation phase response
- laser input impedance

Other laser measurements including linewidth, chirp, and RIN are discussed in HP Application Note 1550-5 (or 371).

Modulation Bandwidth, Frequency Response, and Conversion Efficiency

Modulation bandwidth refers to how fast a laser can be intensity modulated, while conversion efficiency (responsivity) refers to how efficiently an electrical signal driving a laser is converted to modulated light. Although responsivity is often used to describe a static or DC parameter, the conversion efficiency of a device for modulation signals is a dynamic characteristic and can be referred to as “slope responsivity.”

It is not unusual for slope responsivity to vary according to how fast the electrical signal is varied. As the frequency of modulation increases, eventually the conversion efficiency will degrade or “roll off.” The frequency where the conversion efficiency drops to one-half of the maximum is the “3 dB

point” (when data is displayed logarithmically) and determines a laser’s modulation bandwidth. Distortion of modulation signals will occur if the frequency response is not “flat” and there are frequency components which exceed a laser’s bandwidth.

The measurement of modulation bandwidth consists of stimulating a laser with an electrical (microwave or RF) signal and measuring its response (modulated light) with a lightwave receiver. Normally the frequency of an electrical signal into a laser is swept to allow characterization of the laser over a wide range of modulation frequencies.

Measurement Results and Interpretation

Figure 5 shows the measurement of the conversion efficiency of the laser as a function of modulation frequency. The display units are Watts per Amp (the vertical axis). In this case, the display is in a logarithmic format where 0 dB represents 1 watt per amp. The horizontal axis is modulation frequency, indicating that the measurement is being made over a wide range of frequencies, in this case from 300 kHz to 3 GHz.

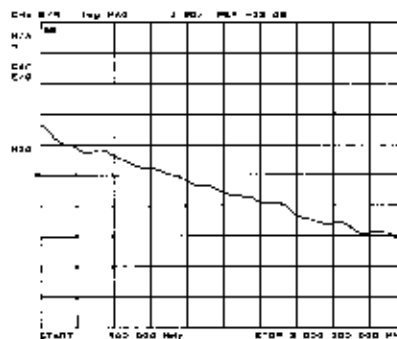

Figure 5. E/O modulation bandwidth measurement

As stated, this measurement indicates how fast the laser can be modulated. This particular laser has a modulation bandwidth of about 1.5 GHz. Beyond this frequency, the conversion efficiency is gradually degraded.

There are two significant components that limit the modulation bandwidth. One is the actual construction of a laser including the physical dimensions and fabrication process. The other is how efficiently an electrical signal is delivered to the laser. (See “Laser input impedance.”)

Measurement Procedure

An accurate measurement requires a “user calibration.” A user calibration will allow the LCA to remove the response of the test system, including the electrical cables, optical fiber, and the instrument itself. Prior to the actual calibration step, the LCA needs to be configured. This includes:

- start and stop frequencies
- sweep type (linear or logarithmic)
- number of measurement points
- measurement sweep time
- source power level

Note: LCAs have a “Guided Setup” feature that leads the user through all the steps that are described here. Guided setup is accessed by pressing SYSTEM key and the [Guided setup] soft-key. The following text discusses the processes that the guided setup executes.

To perform a simple frequency response calibration, the connections shown in Figure 6 must be made. The analyzer measures the appropriate paths so the frequency and phase response of the “unknown” path(s) is/are then characterized. The analyzer then uses this information in conjunction with the internal calibration data to generate an error matrix. (The lightwave source and receiver characteristics are pre-determined during a factory calibration and stored in memory. The storage method depends on the type of LCA used). The end result is the displayed response of the laser under test alone.

After the calibration is complete, one might expect to see a flat response at 0 dB indicating the test system response has been removed. When using an HP 8702, the display seen upon completion of the “response” calibration process will not necessarily be a flat line. The laser used in the calibration is still connected and has become the DUT. Thus, its response is displayed until it is replaced with the actual test device. When the HP 8703 calibration is completed, no response (other than noise) is displayed until an E/O test device is connected between the electrical and optical measurement planes.

In addition to the simple response calibration, there are also the “response plus isolation” and the “response plus match” calibrations. The isolation calibration is used for high insertion loss (low conversion efficiency) devices where any signal leakage within the instrument may be significant relative to the

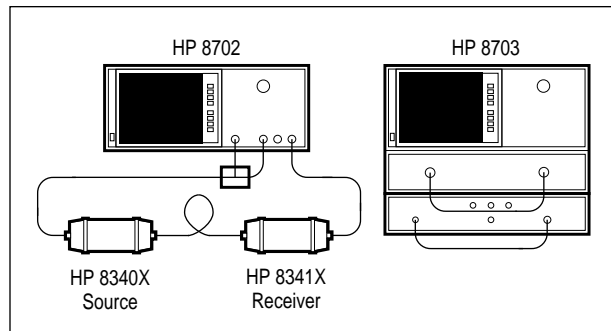

Figure 6. E/O calibration configuration

actual signals measured. The match calibration is used to remove the effects of reflections between the instrument electrical test port and the laser under test. If the laser being tested has a poor electrical input match, the response and match calibration can provide a significant improvement in measurement accuracy. (The response and match calibration is only available with the HP 8703 LCA.) An example of the response plus match calibration is found in the section on O/E receiver measurements.

Once the setup and calibration have been completed, the laser under test is connected and accurate measurements can be made.

Accuracy Considerations

There are several items to consider with respect to measurement accuracy. These include:

- Keeping all electrical and optical connectors clean and in good condition
- Operating the test device in linear regions (unsaturated conditions)
- Avoid overdriving the instrument receiver
- Minimizing cable movement
- Allowing the instrument to “warm-up”
- Keeping both optical and electrical reflections at a minimum (for transmission measurements)

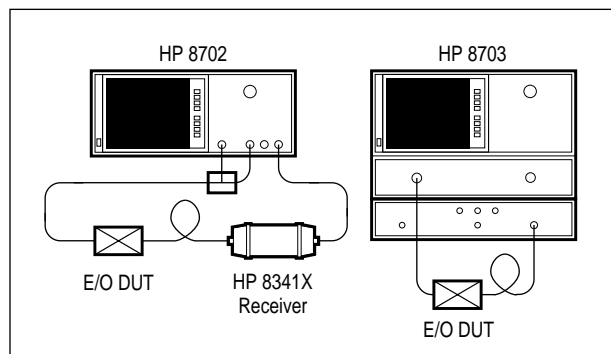

Figure 7. E/O measurement

The Effects of Bias on Laser Performance

The frequency response of a laser is also dependent on biasing conditions. As the DC bias of the laser is increased, the bandwidth will generally increase. This is typically due to the “relaxation oscillation” characteristics that vary with bias. The relaxation oscillation phenomenon creates a resonance in the frequency response, noise, and distortion of the laser.

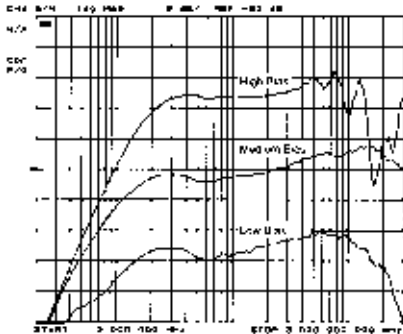

Figure 8. Composite plot of bandwidth at 3 bias levels

Figure 8 is a composite of a bandwidth measurement made at three different bias levels. (The horizontal axis is log frequency.) As bias is increased, both responsivity and bandwidth increase. For this laser, as bias reaches a certain point, the high-end response begins to degrade.

Note in the two lower traces that the response tends to peak before rolling off. This is the region of relaxation oscillation. Care must be taken when modulating a laser in this region, because this is where noise and distortion properties are often at their worst. (See HP Application Note 1550-5 (or 371), “Measuring Modulated Light.”)

Laser Pulse Measurements

Frequency domain information (modulation bandwidth) is related to time domain performance using the analyzer’s time domain feature. An LCA uses the measured frequency domain (bandwidth) data and mathematically manipulates it through a form of an inverse Fourier transform to predict the effective step and/or impulse response of a laser. (See Appendix 2, “Operation in the time domain;” *Basic considerations.*)

Measurement Results and Interpretation

Figure 9 shows the predicted impulse response of a high-speed laser. The data is displayed in a linear magnitude format (as opposed to logarithmically in dB). Several items of information are available from this measurement. One is basic impulse width, which is a measure of device speed. Two time values are shown. The “PW” value is the time between markers at the half-maximum points. However, part of the response is due to the finite bandwidth of the instrument itself. The “Net PW” value is impulse response with the instrument’s response removed.



Figure 9. E/O impulse response

Marker 1, at 10.337 ns, is the effective delay or propagation time through the laser device from the electrical input to the optical output. The device has a long length of fiber pigtail which is the main contributor to the total delay.

Note also that there is a secondary impulse. This typically indicates the presence of a reflection and re-reflection.

Figure 10 shows the predicted step response of the same laser. From this measurement we can determine risetime, ringing, and overshoot performance. In general, these parameters are directly related to the frequency response of the device. (For a comparison of time-domain measurements generated by an LCA versus an oscilloscope, see Figure 24, page 14 under Photodiode Pulse Measurements).

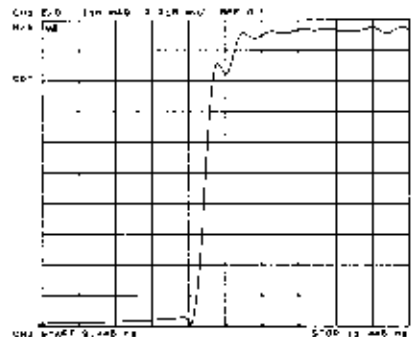

Figure 10. E/O step response

Measurement Procedure

Pulse measurements are generated by manipulating measured frequency response data. Consequently, the measurement procedure is almost identical to that used for the modulation bandwidth. (Potential differences exist due to requirements of the mathematical transform. See Appendix 2, "Operation in the time domain.")

Laser Reflection Sensitivity

The frequency response of a laser may be modified if light is reflected back into the laser's cavity. The reflection sensitivity of a laser can be measured as shown in Figure 11.

Measurement Procedure

The measurement setup is similar to the measurement of modulation bandwidth. In addition, a directional coupler is inserted in the optical path (prior to calibration) in order to monitor the transmitted light and minimize the instrument's response to the reflected light. The controlled reflection is connected to the other arm of the coupler. For an accurate measurement, it is essential that all optical reflections, excepting the controlled reflection, be kept at a minimum.

Typically, a laser's frequency response with back-reflected light is compared to the response when no reflections are present. The response calibration for the reflection sensitivity measurement (under the "Guided setup" menu) normalizes the frequency response to a flat line when no

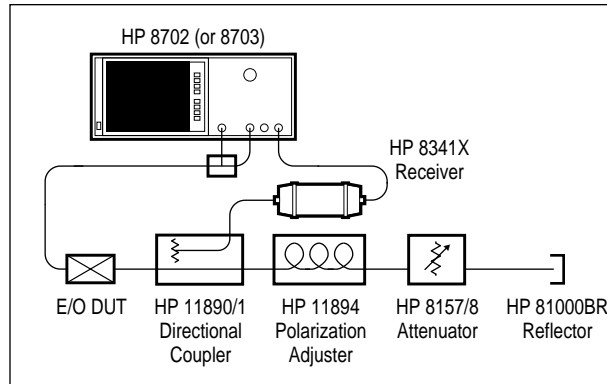

Figure 11.
Reflection sensitivity setup

reflections are present. As the back-reflection is increased, and the polarization of the reflected light is adjusted for worst case results, the modulation response will deviate from this normalized trace and show the reflection sensitivity.

Measurement Interpretation

In this case, the responses for several levels of reflections are shown in Figure 12, a composite diagram (through offsetting subsequent measurements by changing the display reference level). The magnitude and polarization of the reflected light are adjusted while the laser's output is monitored by the LCA. Depending on how well the laser is isolated, and its inherent sensitivity, the frequency response of the laser can be significantly impacted by reflected light. In the worst case, (a reflection of approximately 4 dB return loss) the modulation response shows a 3 dB peak-to-peak variation.

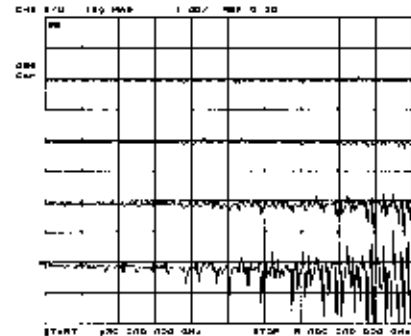

Figure 12. Reflection sensitivity for several levels of reflection

When a laser is used in an actual system, the amount of back-reflected light may be unknown. Thus, it is desirable to develop a robust laser whose characteristics will be consistent over a diversity of operating environments.

Modulation Phase Response

Ideally, a laser's modulation envelope will exhibit a linear phase response versus modulation frequency. If the relative phase relationships of the modulation frequencies do not remain constant, a form of distortion will occur. The phase response of the laser can be displayed in two ways. One way is to display the phase response directly. The second is to display the phase response in a "delay" format.

Measurement Procedure and Interpretation

Phase data is displayed by simply choosing the data format to be “phase” as opposed to the default “log mag.” If the DUT has any significant length in either the optical or electrical path, some compensation in length (through the electrical delay function under the “Scale Ref” key) will be required for viewing the phase response of the laser. In this measurement, 10.315 ns of electrical delay is added, because the fiber pigtail is about 2 m long.

The phase response often “follows” the frequency response. The frequency response of this laser rolls off at the same frequency range where the phase begins to deviate from a ‘linear’ response.

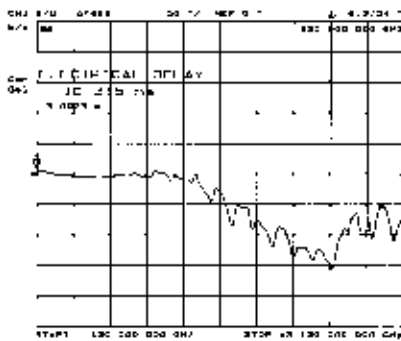

Figure 13. E/O phase response

Sometimes the phase response is easier to interpret and use when viewed in the “delay” data format. The plot of delay is used to indicate the effective time it takes for a modulating signal at

the input of the E/O DUT to exit the device as modulated light. Ideally, this transition time will be the same for all modulation frequencies of interest.

Figure 14 shows the delay for a 3 GHz laser. The average propagation time over the 3 GHz bandwidth is near 6.3 ns.

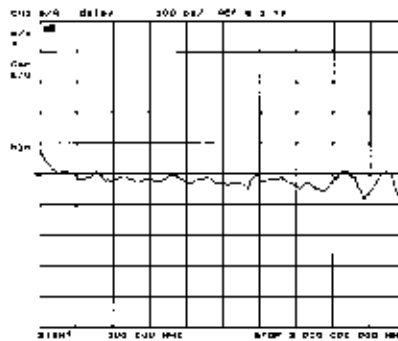

Figure 14. E/O delay measurement

Laser Input Impedance

The conversion efficiency of a laser is dependent not only on the inherent properties of the laser, but also on how efficiently the electrical modulation signal is delivered to the laser. High-speed modulation signals are generally transmitted to the laser over transmission lines with a 50 or 75 ohm characteristic impedance. Maximum power transfer will occur if the input impedance of the laser is the same as the transmission line.

Unfortunately, the input impedance of an active laser is much lower than the transmission system used to drive it. Two problems occur when such an impedance mismatch exists. First, a significant amount of energy will be reflected at the transmission line/laser interface. This reflected energy may eventually be re-reflected and distort the desired data signal. The second problem is that the reflected energy is “wasted” since it is never effectively used to modulate the laser. Thus, the overall conversion efficiency of the laser is degraded.

Measurement Procedure

Figure 15 shows the return loss of a laser with a simple resistive matching circuit as measured on the component analyzer. The measurement is made by sending a swept RF signal to the laser under test and measuring the energy that reflects back. The setup and calibration procedure will depend on the model of LCA used. In all cases, a calibration kit containing known electrical reflection standards is required to improve the accuracy of the reflection measurements.

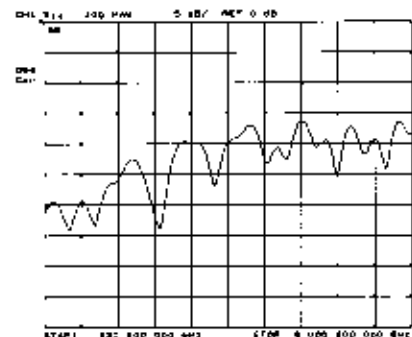

Figure 15. E/O return loss measurement

Measurement Interpretation

The return loss over a 6 GHz range varies from a best case of nearly -34 dB to a worst case of -17 dB. It is not unusual for the reflection level to get worse as the modulation frequency is increased.

Return loss is the ratio of reflected to incident energy ($10 \log(P_{\text{refl}}/P_{\text{inc}})$). The larger the return loss magnitude, the smaller the reflected signal and the better the impedance match.

Figure 16 uses the same measured data as the return loss plot, except in this case the data is displayed in a Smith Chart format. A Smith Chart is a form of an impedance map. The display shows the laser input impedance as a function of frequency. For this laser, the impedance is close to 50 ohms over the 6 GHz range,

as the response does not deviate much from the center of the chart. The Smith Chart data presentation is selected under the "Format" key menu.

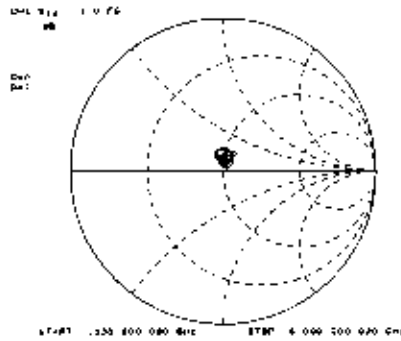

Figure 16. Return loss in Smith chart format

The impedance data from the Smith Chart can be used to model the input structure of the laser. The laser's effective input impedance can be improved with a matching network. Simple methods are usually resistive, while more efficient but complex methods use reactive elements.

Implications of Impedance Mismatch on Measurement Accuracy

When the input impedance of the E/O device under test is far from 50 ohms, a significant portion of the electrical energy sent to the device will be reflected. This reflected energy can degrade measurement accuracy. This is typically seen as ripple in frequency response measurements. Two techniques are available to overcome this problem including the response/match calibration (discussed in O/E measurements) and gating (discussed in Appendix 2, "Operation in the time domain").

Electro-optic External Modulator Measurements

External intensity modulators can be characterized in much the same way as laser sources. This is another class of E/O measurements where the stimulus is a swept frequency electrical signal and the response out of the modulator is intensity modulated light. In particular, modulation bandwidth, phase, and electrical impedance measurements are made with the component analyzer in the same configuration that is used for laser measurements.

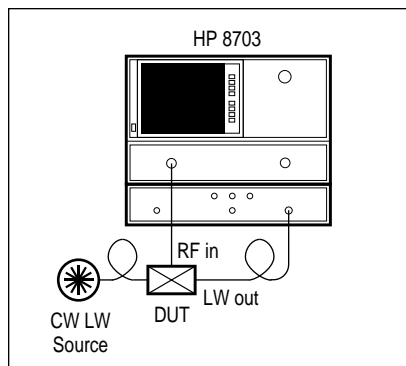

Figure 17. E/O modulator measurement setup

However, a significant difference exists due to the modulator being a three-port device. While the frequency response of a modulator is often independent of the input optical power, the responsivity is not. The conversion efficiency of the modulator is not only a function of the electrical input, but also the level of the optical input.

The LCA measurement compares the output modulation power to the input modulation current. A responsivity in Watts per Amp is then computed and displayed. If the input optical power is increased, the output modulation will typically also increase. Thus, the apparent responsivity will increase. This means that the modulator responsivity measurement is valid only for the specific optical input power that existed when the measurement was performed. The frequency response is typically valid over a wide range of input powers.

Figure 18 is a measurement of a wide bandwidth external modulator. The unusual response at the low frequency range is due to the efficiency of the electrical impedance matching circuitry.

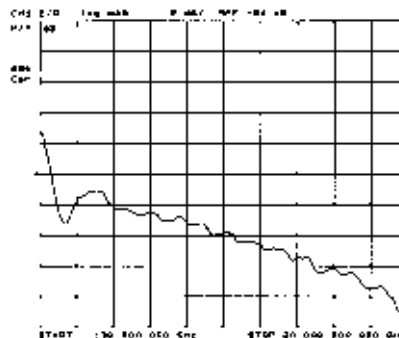

Figure 18. Modulator bandwidth

Similar to the process used for laser measurements, the phase response and electrical input impedance can also be characterized. The frequency domain information can also be used to predict the step and impulse responses.

Lasers are typically described by an input current versus output power relationship. The preferred description for a modulator is often an input voltage versus output power relationship. Because LCA measurements assume a 50 ohm measurement environment, the LCA modulator measurement in Watts per Amp can be converted to Watts per volt by scaling (dividing) the measurement by 50. With the HP 8703, this can be achieved by setting the numerator 'K' (gain) term of the coefficient model to 50, loading the model into memory, and dividing the data by memory. These functions are under the "Display" key.

Lightwave Receiver Measurements(O/E)

The measurements that the LCA makes on lightwave receivers are in many ways similar to those made on lightwave sources. In this case, the stimulus will be modulated light and the response will be “demodulated” electrical signals. Measurements include:

- photodiode responsivity and modulation bandwidth
- step and impulse response
- characterization and improvement of the electrical output impedance

As with the laser source, bandwidth measurements are relevant to pulse rise and fall times, while impedance measurements are important to minimize signal reflections and maximize electrical power transfer. Optical power reflections are discussed in “Optical components: Reflection measurements.”

Photodiode Modulation Bandwidth, Frequency Response, and Conversion Efficiency

As discussed earlier, photodiode conversion efficiency refers to how a change in optical power is converted to a change in output electrical current. As the frequency of modulation increases, eventually the receiver conversion efficiency will rolloff. Thus, the device has a limited modulation bandwidth.

The measurement of modulation bandwidth consists of stimulating the photodiode with a source of modulated light and measuring the output response (RF or microwave) current with an

electrical receiver. Normally the frequency of the modulation is swept to allow examination of the photodiode over a wide range of modulation frequencies.

Measurement Results and Interpretation

The instrument display of Figure 19 shows the conversion efficiency of the photodiode as a function of modulation frequency. The vertical axis display units are Amps per Watt and the horizontal axis is modulation frequency. In this case, the vertical axis is in a logarithmic format where 0 dB (the center line of the display) represents 1 Amp per Watt.

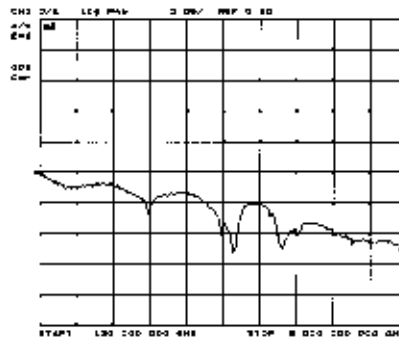

Figure 19. O/E bandwidth and responsivity measurement

The photodiode under test has a modulation bandwidth of approximately 1.5 to 2 GHz. The frequency response also shows some distinct resonances that will impact the time-domain (step or impulse) performance, as shown in Figures 22 and 23.

Measurement Procedure

The measurement process is virtually identical to the laser measurement. An accurate measurement requires a user calibration. This will allow the LCA to remove the response of

the test system including the electrical cables, optical fiber, and the instrument itself. Prior to the actual calibration step, the LCA needs to be configured. This includes:

- start and stop frequencies
- sweep type (linear or logarithmic)
- number of measurement points
- measurement sweep time
- source power level

Note: LCAs have a “Guided Setup” feature that leads the user through all the steps that are described here. This is the recommended measurement procedure. Guided setup is accessed by pressing the SYSTEM key and the “Guided Setup” softkey. The following text discusses the processes that the guided setup executes.

To perform a simple frequency response calibration, the connections in Figure 20 must be made. The analyzer then measures the appropriate paths. The frequency and phase responses of the “unknown” path(s) is/are then characterized. The analyzer/system uses this information in conjunction with the internal calibration data to generate an error matrix. (The lightwave source and receiver characteristics are predetermined and stored in memory. The storage method depends on the type of LCA used.) The end result is that the frequency and phase responses of the entire test system are removed from the measurement so that the displayed response is only that of the photodiode under test.

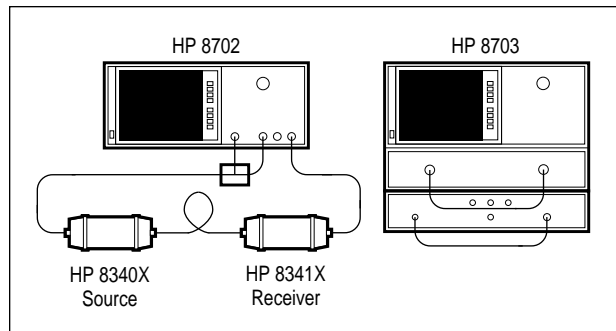

Figure 20. O/E calibration configuration

After completion of the calibration, one might expect to see a flat response at 0 dB indicating the test system response has been removed. When using an HP 8702, the display seen upon completion of the “response” calibration process will not necessarily be a flat line. The O/E receiver used in the calibration, which is still in the measurement path, has become the DUT. Thus its response is now displayed. When the HP 8703 calibration is completed, no response other than noise is displayed until an O/E test device is connected between the electrical and optical measurement planes. In addition to the simple response calibration, there are also the response plus isolation and the response plus match calibrations. The isolation calibration is used for high-insertion loss (low conversion efficiency) devices, where any signal leakage within the instrument may be significant relative to the actual signals measured. The match calibration is used to remove the effects of reflections between the instrument electrical test port and the photodiode under test. (The response and match calibration is only available with the HP 8703 LCA.)

Once the setup and calibrations have been completed, the instrument is now ready to make accurate measurements. The receiver to be tested is placed in the measurement path and its response can be seen, as in Figure 19 “O/E bandwidth and responsivity measurement”, previously shown.

Response and Match Calibration

The response and match calibration is used to improve measurement uncertainty when the O/E test device has a poor output match. Impedance mismatch leads to standing waves that degrade the measurement of device responsivity. Typically, this problem is more pronounced at higher modulation frequencies.

The response and match calibration uses network analysis error correction techniques to minimize the effects of mismatch. The calibration requires a 1-port electrical reflection calibration in addition to the “thru” transmission calibration for the optical and electrical paths.

Figure 21 is a composite measurement of a high-speed photodiode. The lower trace is a measurement with only the normal response calibration. The upper trace, which has lower ripple, is made using the response and match calibration. The traces are intentionally offset for clarity.

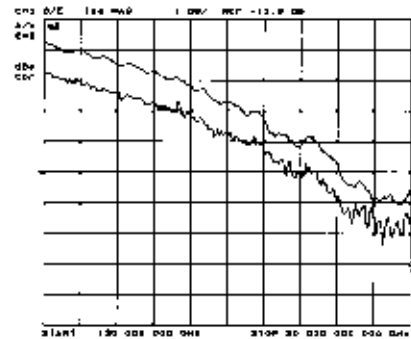

Figure 21. Response and match calibration

The response match calibration can be executed by following the steps in the Guided Setup procedure.

Photodiode Pulse Measurements

To see what implications the device bandwidth and frequency response have on the time domain performance, the time domain transform can be used. This transform uses the measured frequency response data to predict the small signal step and impulse responses of the photodiode. (See Appendix 2, “Operation in the time domain;” *Basic considerations.*)

Figure 22 shows the predicted step response of the same photodiode whose bandwidth was measured in Figure 19. There are several points of interest. The transition from “off” to “on” or risetime (on the order of 180 ps) is dependent upon the device bandwidth (roughly 2 GHz). There is some “ringing” in the step response. The frequency of the ringing correlates directly to the frequency response resonance at 3.2 GHz. Another interesting characteristic is the secondary step that occurs roughly 600 ps after the initial step. This is due to reflections within the device, and is easier to understand by viewing the impulse response.

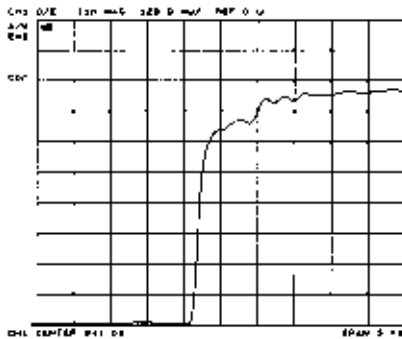

Figure 22. O/E step response

Figure 23 shows the predicted impulse response of the photodiode using the “low-pass impulse” data transform. This measurement provides several pieces of information. First, we see the impulse width. The time between the markers is 123 ps at the full-width half-maximum points.

(This is due not only to the photodiode bandwidth, but also the finite bandwidth of the instrument itself. The “net” pulsewidth is the effective pulsewidth of the photodiode alone after removing the effect of the instrument’s bandwidth.) Another important data point is noted by marker 1 at the peak of the response. This value is 621 ps and is the effective delay of the photodiode or in other words, the average propagation time experienced by the modulation signal from the optical input to the electrical output. A second impulse is noted by marker 2. This response is due to an internal reflection and re-reflection. The re-reflected signal travels a longer distance than the primary impulse, and therefore shows up with a relative delay.

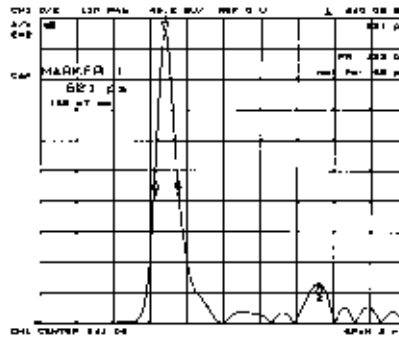

Figure 23. O/E impulse response

The reflection in the photodiode has an adverse affect on the frequency response of the device. If this reflection could be removed, the response would be improved. A technique called

“gating” removes the effects of reflections and is discussed in detail in Appendix 2, “Operation in the time domain;” *Improving measurement accuracy through gating*.

It is interesting to compare the predicted time-domain response with a true time domain measurement. Figure 24 shows a composite of the step response generated by an LCA in comparison with the step response when measured using a sharp optical pulse and a high-speed HP 54120 oscilloscope.

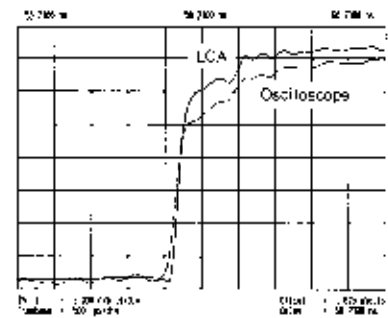

Figure 24. Composite time domain measurements

The two measurements agree very well. It is important to remember that the oscilloscope measurement displays the combined response of the optical pulse, the oscilloscope, and the photodiode. The LCA measurement can calibrate out the response of the test system in order to isolate the response of the DUT. The trace magnitude differences are due to unequal instrument vertical scales.

Photodiode Modulation Phase Measurements

Phase response is also an important parameter. It is important to know if the relative phase of the modulation envelope is distorted in the detection process through a comparison of the phase of the input and output signals over a range of modulation frequencies.

Figure 25 shows the phase response of a high-speed photodiode assembly. When devices have significant length in either the optical or electrical paths, the relative phase (input vs output) will have a large variation. This is not due to the detection process. For example, if a transmission line following the photodiode is one-half wavelength long at 10 GHz, this will result in a 180 degree phase deviation. Of greater concern is the deviation from linear phase. To view this, the effects of path length must be removed. This is achieved by mathematically adding delay to the analyzer reference path. In this case, the delay required is 631 ps.

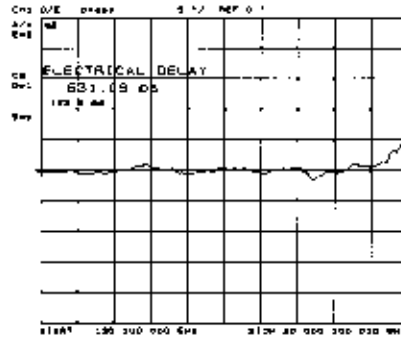

Figure 25. O/E phase measurement

The phase response for this device is well-behaved over the entire 20 GHz measurement range.

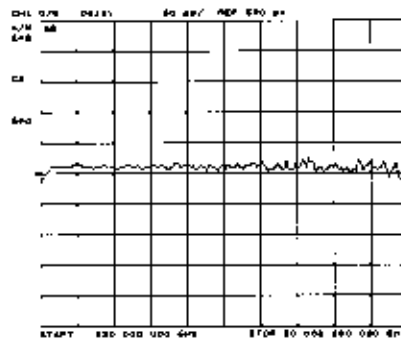

Figure 26. O/E group delay

A related measurement to the phase response is delay versus frequency. Ideally, all frequency components will require the same amount of time to propagate through the device, in both the optical and electrical domains. The delay measurement of the high-speed photodiode shows consistent delay over a 20 GHz bandwidth.

Photodiode Output Impedance

Once the photodiode has converted the modulated light to a proportional electrical current, the task is then to efficiently transmit the demodulated signal to any following electrical components. High-speed systems usually require this transfer over 50 or 75 Ohm transmission lines. The output impedance of a photodiode is usually much higher than 50 (or 75) Ohms. This leads to the possibility of signal reflections and degraded conversion efficiency. If the signal transmitted from the photodiode encounters another impedance mismatch along the transmission path, energy will be reflected back towards the photodiode. The energy will then be re-reflected in the forward direction and potentially interfere with primary signals. (This was demonstrated in the impulse and step measurements of the photodiode discussed earlier. The photodiode had two significant electrical reflections.) Thus reflections can lead to communication degradation.

Measurement Procedure and Interpretation

The setup and measurement of photodiode return loss are identical to the procedure used in characterizing laser return loss. See “Laser input impedance” on page 9. Figure 27 shows the return loss of an optical receiver measured with the component analyzer, displayed on a Smith Chart. A Smith Chart is a form of an impedance map. The display shows the output impedance as a function of frequency. For this receiver, an electrical amplifier follows the photodiode, so the measured impedance is essentially that of the amplifier. Over the 6 GHz measurement range, the impedance stays reasonably close to 50 Ohms (the center of the Smith Chart). The ideal case would be for the impedance to be a constant 50 (or 75) Ohms. The Smith Chart data presentation is selected under the “Format” key menu.

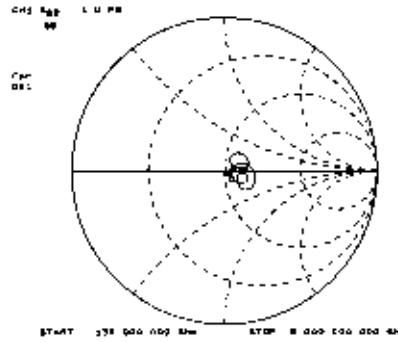

Figure 27. O/E return loss in Smith chart format

The data can also be displayed simply as Return Loss, the ratio of reflected to incident power ($10 \log(P_{\text{refl}}/P_{\text{inc}})$).

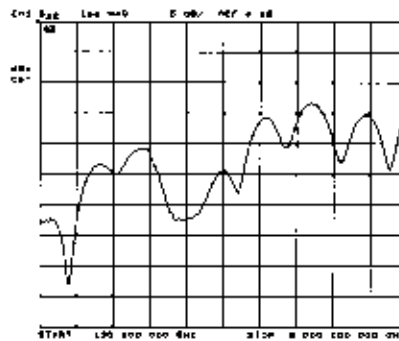

Figure 28. O/E return loss magnitude

Using the time domain feature of the LCA can help to determine the locations of any discontinuities in the electrical path of the photodiode assembly. Figure 29 is a time/distance representation looking back into a photodiode assembly. (This is the same photodiode measured on pages 12 to 14, where it was shown in a transmission measurement that there were significant reflections.)

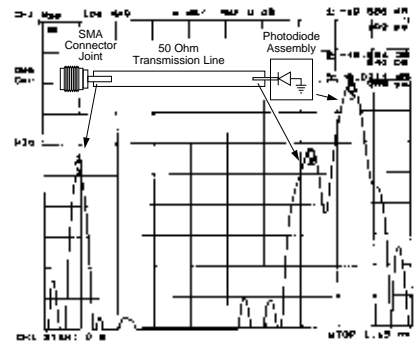

Figure 29. Time domain display of electrical reflections

Optical Components (O/O): Transmission and Reflection Measurements

Consistent, accurate measurements of multi-mode fiber bandwidth are difficult to achieve using an LCA, principally due to the fiber's inherent instability in mode structure and distribution. However, frequency response data can be used in a time domain format to yield precision length and propagation delay transmission measurements and high-resolution reflection measurements.

Transmission Measurements

Fiber Length and Propagation Delay

In the following example we want to determine the length of a section of singlemode fiber. The measurement will be made by using a modulated optical signal with a swept modulation frequency. The range and resolution are directly dependent upon the modulation frequency bandwidth and the number of measurement points. A useful tool built into the HP 8702 and HP 8703 that assists in making time domain measurements is the "transform parameters" function. See Appendix 2, "Operation in the time domain;" *Transform Parameters.*

Measurement Results and Interpretation

Figure 30 shows the result of the fiber transmission measurement displayed in the time-domain. The frequency-domain data has been transformed to predict the impulse response of the fiber.

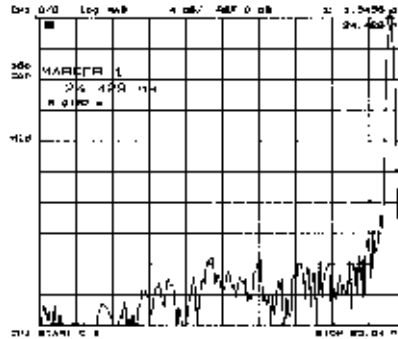

Figure 30. Impulse response of a length of fiber

Placing a marker at the peak of the pulse indicates the propagation time through the fiber, 24.429 ns. If we know the index of refraction, we can calculate the physical length of the fiber. Conversely, if we know the physical length, we can calculate the fiber's index of refraction. The impulse width is due to the finite bandwidth of the LCA and not the fiber itself.

Measurement Procedure

The measurement setup is straightforward. The swept modulated optical source is connected through a short piece of fiber to the instrument's lightwave

receiver. A measurement calibration is required to remove the transmission path length and frequency response errors of the LCA source and receiver.

Care must be taken in setting the instrument sweeptime and IF bandwidth, particularly for "long" devices. This is because the LCA tuned receiver continues to sweep while the stimulus signal is delayed through the fiber. The minimum sweeptime for a given device delay is determined by the combination of IF bandwidth, number of measurement points, and the frequency span. There are no simple rules to follow in setting the critical parameters. The best procedure is to set the sweeptime to a large value, such as 10 seconds, with the DUT connected, prior to performing a calibration. (If there is no response, the sweeptime may need to be increased further). The sweeptime is sequentially reduced until the response changes. The sweeptime is then increased back to a level giving a stable measurement.

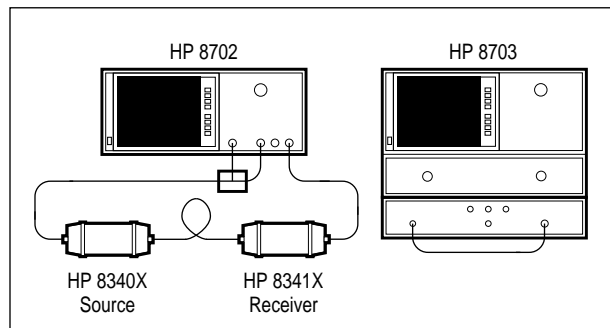

Figure 31. O/O calibration setup

Once the measurement calibration has been performed, the test fiber can be connected between the short fiber and the test system. The initial measurement is made in the frequency domain. Actual length measurements are determined through the time-domain transform. Measurement accuracy is discussed in Appendix 2, "Operation in the time-domain."

Fiber Modulation Phase Stability

In certain fiber optic microwave link applications, it is important for the microwave signal to have a very stable phase response relative to other signals propagating on different fibers or through different media. If the index of refraction varies with temperature, or some other environmental parameter, the carrier (light) velocity and thus the modulation envelope will experience a relative phase shift.

Because we are attempting to measure a change in the fiber characteristics, the setup and calibration procedures are different than for most measurements. In this case, we calibrate the instrument with the fiber under test connected to the instrument.

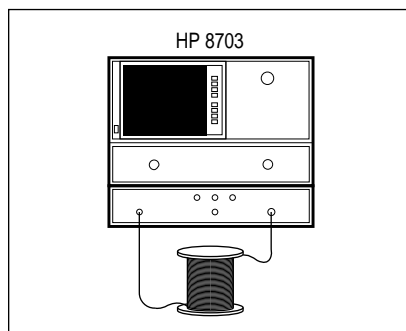

Figure 32. Phase stability calibration

With the fiber under test in place during the calibration, we effectively remove any response present in an ambient environment. Care must be taken that effects other than the parameter of interest (for example temperature) do not impact the measurement. For instance, any bending of the cable after calibration can cause a change in the phase response.

For this measurement, the device under test is a 10 km spool of fiber. The measurement is made with a CW modulation frequency of 10 GHz. Instead of sweeping frequency, the measurement is made over a 16 minute time span. It can be seen that the modulation phase response does vary significantly with time. In this measurement, the relative phase response begins at roughly -60 degrees (some phase change has already occurred between the time the calibration was completed and the measurement began). The phase continues to change to -180 degrees, where the analyzer "rolls over" to $+180$ degrees. For the given time span, the total variation is approximately 150 degrees.

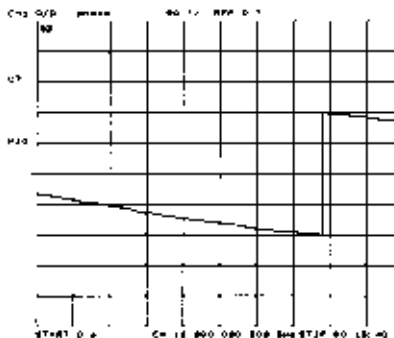

Figure 33. O/O phase measurement vs. time

As shorter lengths of fiber are examined, the phase response variance versus time will become smaller. However, other parameters such as temperature or physical stress can cause phase variation, even over short runs of cable.

Reflection Measurements

In a high-speed fiber optic system, reflected light can cause a variety of problems and come from several different sources. Both distributed feedback (DFB) and Fabry-Perot lasers are sensitive to light reflecting back into their resonant structures. Both noise and modulation characteristics can be degraded. In a communication system, re-reflected light can arrive at the receiver and potentially cause "bit errors." To minimize these effects, it is important to characterize the amount of light that is reflected off of optical components and determine where the reflections occur.

Methods for Measuring Lightwave Reflections vs. Distance

In component development it is often necessary to determine the physical location of the reflection. If there are multiple reflections, we must determine which reflections contribute significantly to the total amount of reflected light. There are a variety of methods for measuring reflected light versus distance or position. Among these methods are optical time-domain reflectometers (OTDR), optical coherence-domain reflectometers (such as the HP 8504A precision reflectometer), and optical frequency domain reflectometers (OFDR). The LCA uses the OFDR

technique. Each technique has advantages and disadvantages. (When measurements of total return loss are required, without spatial information, a power meter solution such as the HP 8153A is used.)

Determining both the magnitude and location of reflections in lightwave components require techniques beyond the capabilities of a multimeter or conventional OTDR.

The LCA is well suited for making high resolution reflection measurements of lightwave components. The LCA does not use a pulse technique and consequently does not suffer from “deadzone” problems typical of OTDRs. Instead, a wide bandwidth swept frequency technique is used, which leads to precision location and resolution of each reflection.

The setup for a reflection measurement requires that the lightwave source be routed to the input of a directional coupler. The DUT is connected to the coupler output arm. The coupled arm is connected to the LCA receiver.

The resolution of the LCA in OFDR mode is dependent upon the modulation frequency range. The wider the bandwidth, the higher is the two-event resolution. The closest that two reflections can be and still be resolved is referred to as response resolution. (See Appendix 2, “Operation in the time domain;” *Basic considerations*.) A 20 GHz instrument bandwidth can provide 5 mm of two-event resolution while a 3 GHz bandwidth can provide 33 mm (in fiber). If higher resolution is required, the HP 8504 precision reflectometer offers better than 25 micron 2-event resolution. Measurement sensitivity is enhanced through trace averaging and setting the LCA IF bandwidth to a low value, such as 30 Hz. This usually slows the measurement rate, but will reduce the effects of noise. Smaller reflections can then be seen.

Once the frequency range has been set, a calibration must be performed. The simplest calibration is achieved by using the open-ended test port as a Fresnel reflection standard. This assumes that the port is polished, clean, and in good condition. With this

calibration “standard” in place, the analyzer measures the light reflected off the test port as the frequency of modulation is swept over the selected bandwidth. Thus, the frequency response imperfections of the LCA are mathematically removed from the measurement.

Figure 35 shows the reflections from a lightwave cable consisting of three patchcords with simple PC connectors. The magnitude of the reflection for each connector is easily seen. Setting the index of refraction to 1.46, and using the marker functions, the length of each patchcord can be determined, at 1.514m, 1.761m, and 1.756m respectively.

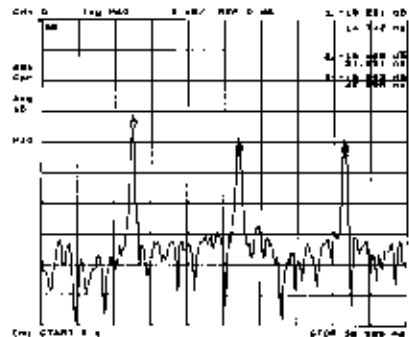

Figure 35. Multiple reflection measurement

Measurement accuracy is discussed in Appendix 2, “Operation in the time domain.”

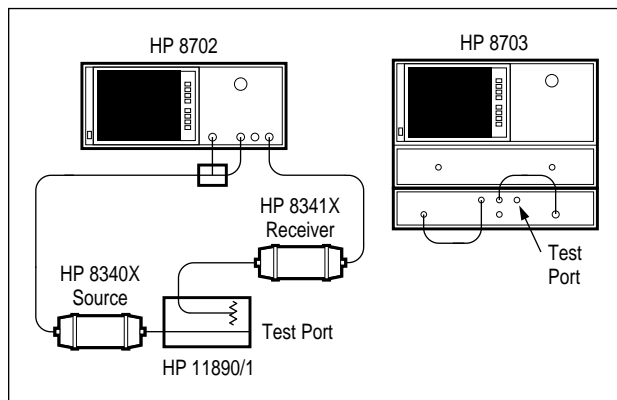

Figure 34. OFDR setup

There are limitations in the OFDR technique. The higher the two-event resolution, the smaller the overall measurement range. For instance, the 20 GHz configuration with 201 measurement points offers the best two-event resolution (5 mm in fiber), but the one-way range is only 1 meter. The measurement range can be increased by increasing the number of measurement points, or decreasing the instrument's frequency range, which will in turn degrade the two-event resolution. (See Appendix 2, "Operating in the time domain.")

Achieving Both High Resolution and Long Range

Some measurement scenarios require both high resolution and long range. This can be achieved using the LCA in a "2-pass" measurement technique. The analyzer is first set up in a narrow bandwidth mode that provides a long enough range to locate the region of interest. The propagation time to the area of interest is determined. The LCA's frequency range is then widened to provide the two-event resolution required to isolate the individual reflections. The electrical delay equal to the propagation time to the reflections is added to the measurement (using the electrical delay function under the Scale Reference key). This effectively pulls the reflections of interest into the instrument's reduced range.

A High-resolution Measurement of Differential Length

To demonstrate this procedure, a long spool of fiber with a 1X2 coupler at the end was measured. The differential length of the two arms of the coupler is the desired measurement.

The first task is to locate the coupler at the end of the fiber. The spool is estimated to be 10 km in length. The measurement span is configured to provide 12 km of range. This requires a frequency span of only 2.5 MHz. After a response calibration similar to that described above, the spool and coupler are then connected to the test port, and the measurement of Figure 36 is generated.

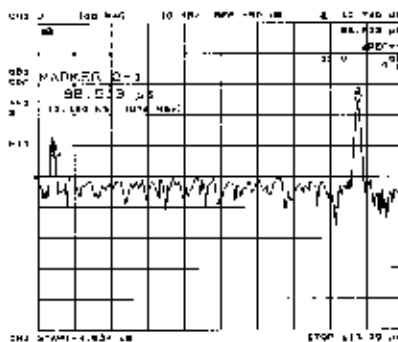

Figure 36. OFDR measurement in wide span

Two reflections are seen. One at time 0, corresponding to the fiber connection to the instrument, and another over 98.513 μ s (two-way) or 10.114 km (one way), at the cable end.

The task is now to zoom in on the cable end and examine the reflections in high resolution mode. The analyzer bandwidth is increased to 20 GHz and placed in "set freq low pass" mode. The analyzer is then recalibrated with the DUT disconnected.

(The sweep time considerations discussed in O/O transmission measurements are even more critical here, since the signal is traversing the length of the fiber twice before being detected.) 98.513 μ s of electrical delay is added, and while in the time mode, the span is reduced to show two reflections very close together. These are the Fresnel reflections at the two coupler outputs, which are measured to have a differential path length of 18 mm. The two-pass measurement technique has provided millimeter resolution at the end of a 10 km cable.

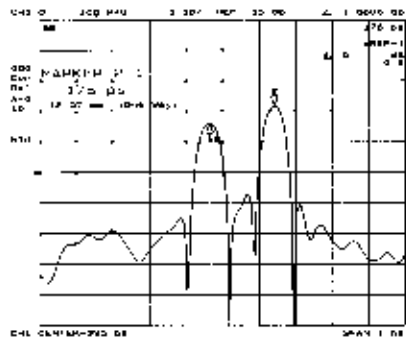

Figure 37. Zooming in on the cable end

Note: This technique is susceptible to alias responses. The reflection at the instrument's test port, or where the coupler is connected to the fiber spool, can potentially show up in another region due to the limitations of the transform. To determine if a response is real or an alias, the number of measurement points should be changed and the measurement repeated. True events will maintain their location, while alias events will move.

Electrical Component Measurements (E/E)

Lightwave component analyzers have the capability to operate as RF and microwave network analyzers. They can then be used to characterize the electrical components used in lightwave systems including amplifiers, filters, couplers etc. For tutorial information on RF and microwave network analysis please refer to the HP "Vector Seminar" booklet (HP literature number 5954-8355.)

Appendix 1: Signal Relationships in Opto-electric Devices

Signal Relationships Used in Component Measurements

The LCA measurement technique is built upon concepts used in characterizing RF and microwave devices. "S-parameter" or scattering matrix techniques have proven to be convenient ways to characterize device performance. The following section will discuss how similar techniques are used in characterizing devices in the lightwave domain. This is intended to show the basis on which E/O and O/E responsivity measurements are defined.

Figure 38 is a general representation of a lightwave system, showing input and output signals in terms of terminal voltages, input and output currents, and optical modulation power.

S-parameters are used to describe the transmitted and reflected signal flow within a device or network. For the model, the following S-parameters are defined:

$$S_{11} = \frac{b_1}{a_1} \quad (a_2 = 0)$$

$$S_{22} = \frac{b_2}{a_2} \quad (a_1 = 0)$$

where:

$$a_1 = \frac{\Delta V_1}{\sqrt{Z_0}} \quad \text{incident on E/O device} \\ = \Delta I_1 \cdot \sqrt{Z_0}$$

$$b_1 = \frac{\Delta V_1}{\sqrt{Z_0}} \quad \text{reflected from E/O device}$$

$$a_2 = \frac{\Delta V_2}{\sqrt{Z_0}} \quad \text{incident on O/E device}$$

$$b_2 = \frac{\Delta V_2}{\sqrt{Z_0}} \quad \text{transmitted from O/E device} \\ = \Delta I_2 \cdot \sqrt{Z_0}$$

It is interesting to note that "delta" voltages and currents are used as opposed to RMS values. This is done because we deal with modulation signals in describing lightwave transducers, where a change in optical power is proportional to a change in electrical current or voltage.

The overall system forward gain is defined as:

$$S_{21} = \frac{b_2}{a_1} \quad (a_2 = 0)$$

$$S_{12} = 0 \quad (\text{no reverse transmission is assumed})$$

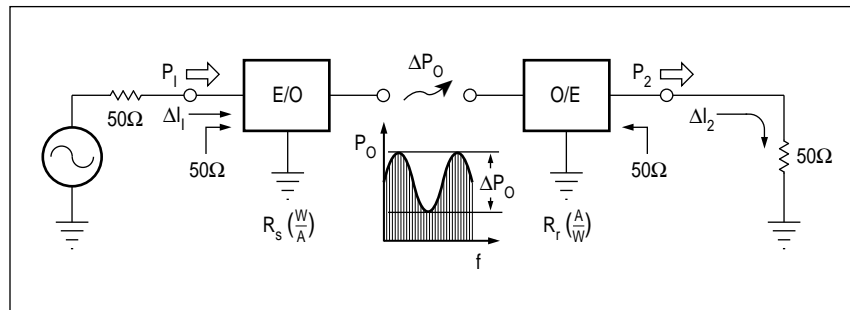

Figure 38. Signal definitions

Though the overall system gain is defined as an S-parameter, the individual transfer functions of the E/O and O/E devices are typically defined in terms of responsivities, because signals in both the optical and electrical domain are used and optical signals do not lend themselves conveniently to S-parameter definitions. Initially, the input impedance of the E/O converter and the output impedance of the O/E converter will be assumed to be Z_0 (thus S_{11} and S_{22} are zero).

$$R_s = \frac{\Delta P_0}{\Delta I_1} = \text{E/O source responsivity}$$

and

$$R_r = \frac{\Delta I_2}{\Delta P_0} = \text{O/E receiver responsivity}$$

Using the above relationships, we can rewrite S_{21} in terms of the transducer responsivities R_s and R_r :

$$\begin{aligned} S_{21} &= \frac{b_2}{a_1} \\ &= \frac{\Delta I_2}{\Delta I_1} \\ &= \frac{(R_r \cdot \Delta P)}{(\Delta P / R_s)} \\ &= R_s \cdot R_r \end{aligned}$$

It is convenient to express the transducer functions logarithmically in decibels. The system power gain from a Z_0 source to a Z_0 load can be defined using the above relationships:

$$|a_1|^2 = \text{Power incident on the E/O converter}$$

$$|b_2|^2 = \text{Power delivered to a } Z_0 \text{ load.}$$

$$\begin{aligned} |S_{21}|^2 &= \frac{|b_2|^2}{|a_1|^2} \\ &= |R_s \cdot R_r|^2 \\ &= \text{System power gain} \end{aligned}$$

$$20 \log_{10} |S_{21}| = \text{System gain in dB}$$

$$= 20 \log_{10} |R_s \cdot R_r|$$

The responsivities R_s and R_r need to be related to some value in order to have meaning as individual quantities expressed logarithmically, just as 0 dB represents an S_{21} of unity or gain of 1. Consequently source responsivity will be expressed in Watts per Amp, which in decibels will be related to a conversion efficiency of 1 W/A. Similarly, receiver conversion efficiency will be relative to 1 A/W.

$$20 \log_{10} |R_s \cdot R_r| = 20 \log_{10} \frac{R_s(\text{W/A})}{1(\text{W/A})} \cdot \frac{R_r(\text{A/W})}{1(\text{A/W})}$$

The individual responsivities can now be expressed individually in decibels:

$$R_s(\text{dB}) = 20 \log_{10} \frac{R_s(\text{W/A})}{1(\text{W/A})}$$

$$R_r(\text{dB}) = 20 \log_{10} \frac{R_r(\text{A/W})}{1(\text{A/W})}$$

This now allows us to express the original equations for responsivity in logarithmic terms:

$$R_s(\text{dB}) = 20 \log_{10} \frac{\Delta P}{\Delta I_1}$$

$$R_r(\text{dB}) = 20 \log_{10} \frac{\Delta I_2}{\Delta P}$$

Responsivity measurements are now based on the LCA's ability to accurately measure optical modulation power (ΔP_0) and modulation current ($\Delta I_{1,2}$). The measurement of modulation current is derived from the system characteristic impedance and a measurement of electrical power. The measurement of optical modulation power is based on a "standard" lightwave receiver whose characteristics are predetermined and known by the LCA.

Appendix 2: Operation in the Time Domain

Basic Considerations

The LCA makes its measurements by sweeping the frequency of modulation. Thus data is measured in the frequency domain. However, the LCA also has the capability to mathematically interpret the frequency domain information and present it in a time domain format. We can then estimate how a device will respond to specific waveforms such as a "step" or "impulse". The time domain transformation can be used in both transmission and reflection measurements, with each supplying different insights into component characteristics. Note: Because the time domain response is derived from the small-signal linear frequency response, it too provides a small-signal, linear prediction of the step and impulse device responses.

To use a LCA for impulse response testing, we make measurements at specific sinusoidal frequencies. The process of adding these discrete sine wave components is expressed mathematically by the inverse discrete Fourier transform (DFT⁻¹).

The time domain conversion process uses a sophisticated, high-speed algorithm that converts frequency domain data to the time domain. The algorithm will calculate the equivalent of either an impulse ("low pass impulse" mode), a step ("low pass step" mode), or an RF burst ("band-pass" mode). The result calculated by the time domain algorithm is the same result that would be measured by the cor-

responding direct measuring system (oscilloscope, pulse generator etc.) with the same bandwidth and pulse shape.

There are advantages and disadvantages in each of the three transform modes. The step response is calculated by taking the integral of the impulse response. The step mode not only provides risetime and transient information, it can also be used to characterize the nature of electrical discontinuities (capacitive, inductive etc.) when making electrical reflection measurements. The low pass impulse mode provides the highest resolution in impulse measurements. Both the step and impulse modes require that the frequency points be harmonically related, and the sweep has to start at the fundamental so the DC term can be extrapolated. (LCA's have a function called "SET FREQ LOW PASS" which ensures harmonically-related frequency points.)

In the bandpass mode, the algorithm is modified to yield the response of an RF burst or light modulated with an RF burst. This mode requires only a constant frequency step size. It offers only the magnitude of the impulse response with twice the pulse width of the low-pass mode. Thus, the resolution of "bandpass" measurements is less than the "impulse" measurement, but is generally easier to perform.

Range and Resolution

Measurement Range

Measurement range is used to describe the largest time span (and consequently the longest distance) that can be displayed within the bounds of the transform. The mathematical transform used generates an "impulse

train" in the time domain, not a single pulse. Consequently, after a certain length of time, the pulse is repeated. This leads to "alias" responses. We cannot distinguish which of the pulses are true responses when we are outside of the alias-free range. The alias free range, in seconds, is given by:

$$AFR = \frac{(N-1)}{\text{Freq. span}}$$

where 'N' is the number of measurement points. Ambiguous measurements will also be generated when the phase rotation through a device is greater than 180 degrees over the frequency step size.

Measurement Resolution

Measurement resolution is a measure of the LCA's ability to locate a single response, in seconds, and is defined as:

$$MR = \frac{(\text{Time span})}{(N-1)}$$

where measurement span is the span of time displayed on the LCA (with the transform active) and N is the number of data points.

As the time span is reduced, the single-event measurement resolution will eventually be limited by the phase accuracy of the instrument. The measurement resolution, in seconds, due to phase accuracy uncertainty is then:

$$MR = \left(\frac{0.003 \cdot \text{Phase uncertainty (deg)}}{\text{Aperture (Hz)}} \right)$$

where the aperture is the measurement frequency range. Phase uncertainty will vary depending upon the type of measurement made, but typically is better than 10 degrees, which leads to sub-picosecond time uncertainties and sub-millimeter distance uncertainties.

Response Resolution

Response resolution is the smallest time (proportional to distance) between two responses, where each response can be isolated and identified.

Lowpass step, impulse:

$$RR = \frac{1}{\text{Freq. span}}$$

Bandpass:

$$RR = \frac{2}{\text{Freq. span}}$$

This assumes that the "windowing" function, which performs some shaping of the pulse or step, is set to the "normal" state (default condition).

Transform Parameters

The HP 8702 and HP 8703 provide a table (displayed on the CRT) that shows how the measurement parameters vary when frequency span, number of measurement points, etc. are adjusted. This eliminates the task of calculating the ranges and resolutions. It is found in the transform menu and is accessed through the "system" key.

Improving Measurement Accuracy Through Gating

Reflected signals can interfere with primary signals, leading to measurement uncertainty. Operating in the time domain, reflected signals can be isolated and mathematically removed, thus improving measurement accuracy.

For transmission measurements of E/O, O/E, O/O, and E/E devices, a reflection-free time-domain impulse response will be shown as a single event. If there are significant reflections in the DUT, there will be additional impulse responses shown later in time.

The time-domain gating function acts as a time “bandpass” filter that passes the primary response and removes the responses due to reflections. Once the reflections have been “gated out”, the measurement can be returned to the frequency domain. The frequency response displayed is as if the reflected signals were no longer present.

Figure 39 shows a photodiode response that is degraded due to internal reflections.

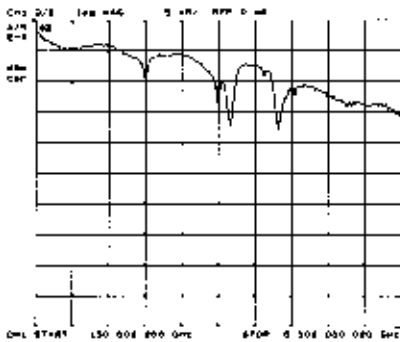

Figure 39.
Degraded frequency response

Analyzing the response in the time domain, the secondary impulse is determined to be due to a reflection.

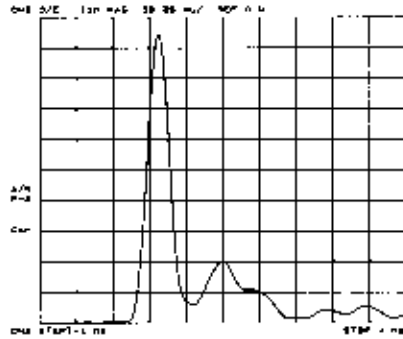

Figure 40. Time domain response (with reflections)

Using the gating function (part of the transform menu), the time gate or “filter” is centered and the span adjusted to reject all but the primary response. The gate center is noted by the ‘T’ and width by the two ‘flag’ markers. The gate is turned on, and the reflection response is removed.

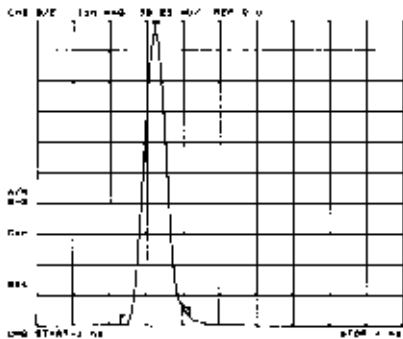

Figure 41. "Gated" time domain response

With the time-domain transform turned off, the gate function may remain active. The frequency response is now shown, but with the effect of the reflection removed. It is apparent that the reflection has a significant effect on the frequency response. Thus, gating provides a useful tool to simulate the results of actually removing unwanted responses.

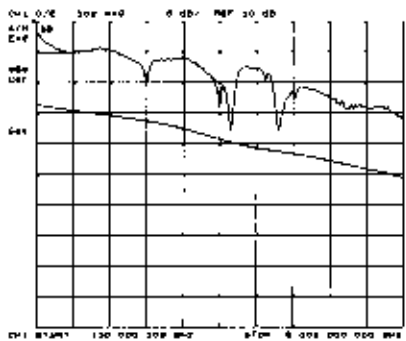

Figure 42. Frequency response with and without gating active (gated trace is offset)

For more information about Hewlett-Packard test and measurement products, and for a current sales office listing, visit our web site, <http://www.hp.com/go/tmdir>.